

# SiT9120

## Standard Frequency Differential Oscillator



### Features

- 31 standard frequencies from 25 MHz to 212.5 MHz
- LVPECL and LVDS output signaling types
- 0.6 ps RMS phase jitter (random) over 12 kHz to 20 MHz bandwidth
- Frequency stability as low as  $\pm 10$  ppm
- Industrial and extended commercial temperature ranges
- Industry-standard packages: 3.2x2.5, 5.0x3.2 and 7.0x5.0 mmxmm
- For any other frequencies between 1 to 625 MHz, refer to SiT9121 and SiT9122 datasheet

### Applications

- 10GB Ethernet, SONET, SATA, SAS, Fibre Channel, PCI-Express
- Telecom, networking, instrumentation, storage, servers



INSTANT  
SAMPLES



GREEN  
SOLUTIONS



LIFETIME  
WARRANTY

### Electrical Characteristics

Parameter and Conditions	Symbol	Min.	Typ.	Max.	Unit	Condition
<b>LVPECL and LVDS, Common Electrical Characteristics</b>						
Supply Voltage	V <sub>dd</sub>	2.97	3.3	3.63	V	
		2.25	2.5	2.75	V	
		2.25	–	3.63	V	Termination schemes in Figures 1 and 2 - XX ordering code
Output Frequency Range	f	25	–	212.5	MHz	See last page for list of standard frequencies
Frequency Stability	F <sub>stab</sub>	-10	–	+10	ppm	Inclusive of initial tolerance, operating temperature, rated power supply voltage, and load variations
		-20	–	+20	ppm	
		-25	–	+25	ppm	
		-50	–	+50	ppm	
First Year Aging	F <sub>aging1</sub>	-2	–	+2	ppm	25°C
10-year Aging	F <sub>aging10</sub>	-5	–	+5	ppm	25°C
Operating Temperature Range	T <sub>use</sub>	-40	–	+85	°C	Industrial
		-20	–	+70	°C	Extended Commercial
Input Voltage High	V <sub>IH</sub>	70%	–	–	V <sub>dd</sub>	Pin 1, OE or $\overline{ST}$
Input Voltage Low	V <sub>IL</sub>	–	–	30%	V <sub>dd</sub>	Pin 1, OE or $\overline{ST}$
Input Pull-up Impedance	Z <sub>in</sub>	–	100	250	k $\Omega$	Pin 1, OE logic high or logic low, or $\overline{ST}$ logic high
		2	–	–	M $\Omega$	Pin 1, $\overline{ST}$ logic low
Start-up Time	T <sub>start</sub>	–	6	10	ms	Measured from the time V <sub>dd</sub> reaches its rated minimum value.
Resume Time	T <sub>resume</sub>	–	6	10	ms	In Standby mode, measured from the time $\overline{ST}$ pin crosses 50% threshold.
Duty Cycle	DC	45	–	55	%	Contact SiTime for tighter duty cycle
<b>LVPECL, DC and AC Characteristics</b>						
Current Consumption	I <sub>dd</sub>	–	61	69	mA	Excluding Load Termination Current, V <sub>dd</sub> = 3.3V or 2.5V
OE Disable Supply Current	I <sub>OE</sub>	–	–	35	mA	OE = Low
Output Disable Leakage Current	I <sub>leak</sub>	–	–	1	$\mu$ A	OE = Low
Standby Current	I <sub>std</sub>	–	–	100	$\mu$ A	$\overline{ST}$ = Low, for all V <sub>dds</sub>
Maximum Output Current	I <sub>driver</sub>	–	–	30	mA	Maximum average current drawn from OUT+ or OUT-
Output High Voltage	V <sub>OH</sub>	V <sub>dd</sub> -1.1	–	V <sub>dd</sub> -0.7	V	See Figure 1(a)
Output Low Voltage	V <sub>OL</sub>	V <sub>dd</sub> -1.9	–	V <sub>dd</sub> -1.5	V	See Figure 1(a)
Output Differential Voltage Swing	V <sub>Swing</sub>	1.2	1.6	2.0	V	See Figure 1(b)
Rise/Fall Time	T <sub>r</sub> , T <sub>f</sub>	–	300	500	ps	20% to 80%, see Figure 1(a)
OE Enable/Disable Time	T <sub>oe</sub>	–	–	115	ns	f = 212.5 MHz - For other frequencies, T <sub>oe</sub> = 100ns + 3 period
RMS Period Jitter	T <sub>jitt</sub>	–	1.2	1.7	ps	f = 100 MHz, V <sub>DD</sub> = 3.3V or 2.5V
		–	1.2	1.7	ps	f = 156.25 MHz, V <sub>DD</sub> = 3.3V or 2.5V
		–	1.2	1.7	ps	f = 212.5 MHz, V <sub>DD</sub> = 3.3V or 2.5V
RMS Phase Jitter (random)	T <sub>phj</sub>	–	0.6	0.85	ps	f = 156.25 MHz, Integration bandwidth = 12 kHz to 20 MHz, all V <sub>dds</sub>
<b>LVDS, DC and AC Characteristics</b>						
Current Consumption	I <sub>dd</sub>	–	47	55	mA	Excluding Load Termination Current, V <sub>dd</sub> = 3.3V or 2.5V
OE Disable Supply Current	I <sub>OE</sub>	–	–	35	mA	OE = Low
Differential Output Voltage	V <sub>OD</sub>	250	350	450	mV	See Figure 2

### Electrical Characteristics (continued)

Parameter and Conditions	Symbol	Min.	Typ.	Max.	Unit	Condition
<b>LVDS, DC and AC Characteristics (continued)</b>						
Output Disable Leakage Current	$I_{leak}$	–	–	1	$\mu$ A	OE = Low
Standby Current	$I_{std}$	–	–	100	$\mu$ A	$\overline{ST}$ = Low, for all Vdds
VOD Magnitude Change	$\Delta VOD$	–	–	50	mV	See Figure 2
Offset Voltage	VOS	1.125	1.2	1.375	V	See Figure 2
VOS Magnitude Change	$\Delta VOS$	–	–	50	mV	See Figure 2
Rise/Fall Time	$T_r, T_f$	–	495	600	ps	20% to 80%, see Figure 2
OE Enable/Disable Time	$T_{oe}$	–	–	115	ns	f = 212.5 MHz - For other frequencies, $T_{oe}$ = 100ns + 3 period
RMS Period Jitter	$T_{jitt}$	–	1.2	1.7	ps	f = 100 MHz, VDD = 3.3V or 2.5V
		–	1.2	1.7	ps	f = 156.25 MHz, VDD = 3.3V or 2.5V
		–	1.2	1.7	ps	f = 212.5 MHz, VDD = 3.3V or 2.5V
RMS Phase Jitter (random)	$T_{phj}$	–	0.6	0.85	ps	f = 156.25 MHz, Integration bandwidth = 12 kHz to 20 MHz, all Vdds

### Pin Description

Pin	Map		Functionality
1	OE	Input	H or Open: specified frequency output L: output is high impedance
	$\overline{ST}$	Input	H or Open: specified frequency output L: Device goes to sleep mode. Supply current reduces to $I_{std}$ .
2	NC	NA	No Connect; Leave it floating or connect to GND for better heat dissipation
3	GND	Power	VDD Power Supply Ground
4	OUT+	Output	Oscillator output
5	OUT-	Output	Complementary oscillator output
6	VDD	Power	Power supply voltage

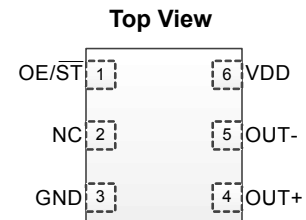

### Absolute Maximum

Attempted operation outside the absolute maximum ratings of the part may cause permanent damage to the part. Actual performance of the IC is only guaranteed within the operational specifications, not at absolute maximum ratings.

Parameter	Min.	Max.	Unit
Storage Temperature	-65	150	°C
VDD	-0.5	4	V
Electrostatic Discharge (HBM)	–	2000	V
Soldering Temperature (follow standard Pb free soldering guidelines)	–	260	°C

### Thermal Consideration

Package	$\theta_{JA}$ , 4 Layer Board (°C/W)	$\theta_{JC}$ , Bottom (°C/W)
7050, 6-pin	142	27
5032, 6-pin	97	20
3225, 6-pin	109	20

### Environmental Compliance

Parameter	Condition/Test Method
Mechanical Shock	MIL-STD-883F, Method 2002
Mechanical Vibration	MIL-STD-883F, Method 2007
Temperature Cycle	JESD22, Method A104
Solderability	MIL-STD-883F, Method 2003
Moisture Sensitivity Level	MSL1 @ 260°C

**Waveform Diagrams**

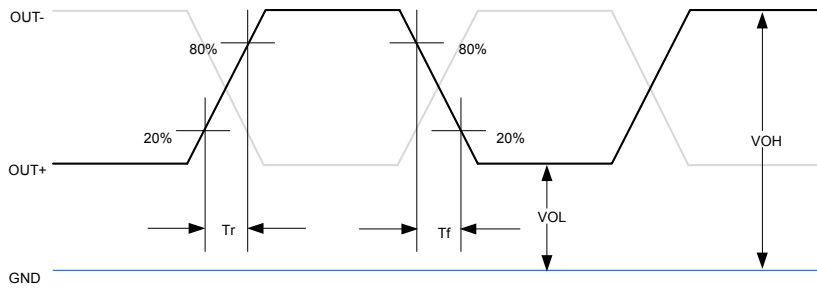

**Figure 1(a). LVPECL Voltage Levels per Differential Pin (OUT+/OUT-)**

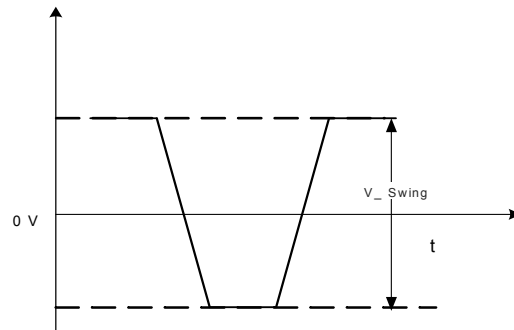

**Figure 1(b). LVPECL Voltage Levels Across Differential Pair**

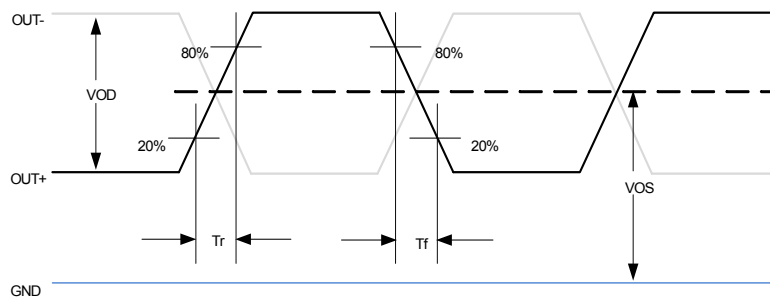

**Figure 2. LVDS Voltage Levels per Differential Pin (OUT+/OUT-)**

**Termination Diagrams**

LVPECL:

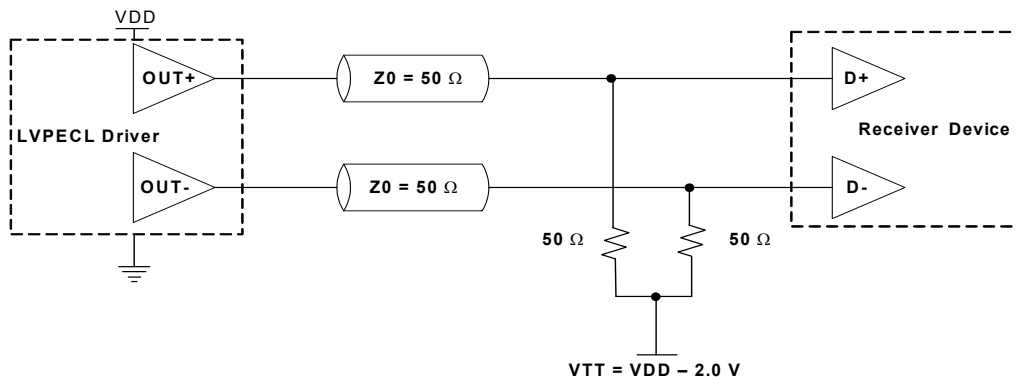

**Figure 3. LVPECL Typical Termination**

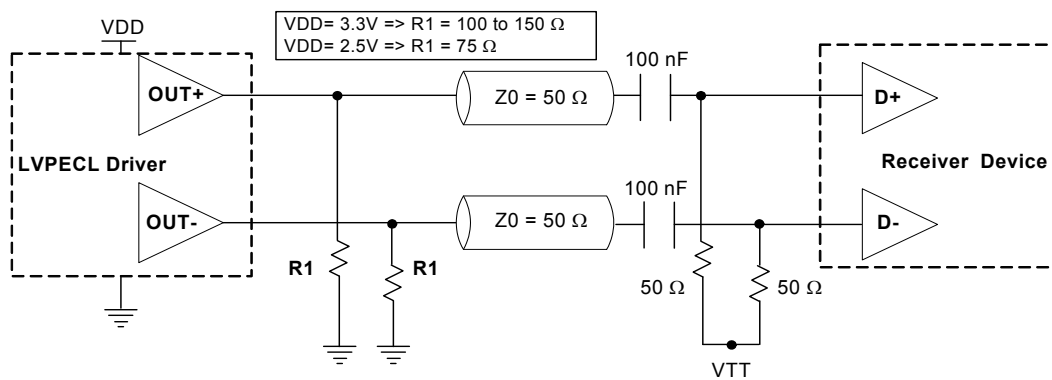

**Figure 4. LVPECL AC Coupled Termination**

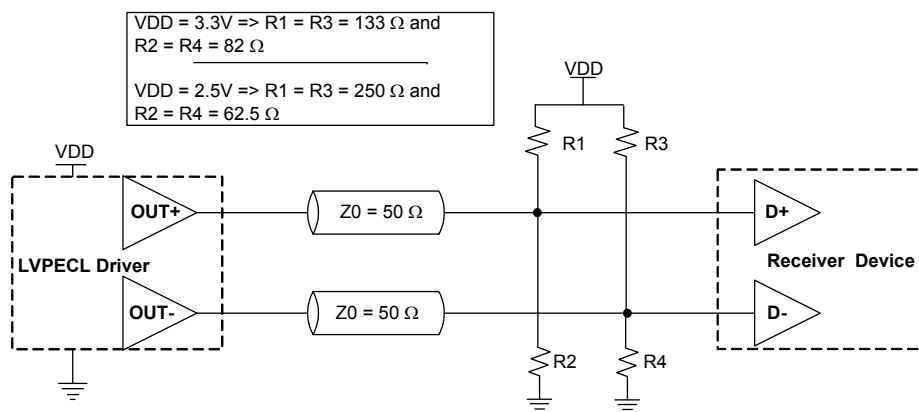

**Figure 5. LVPECL with Thevenin Typical Termination**

LVDS:

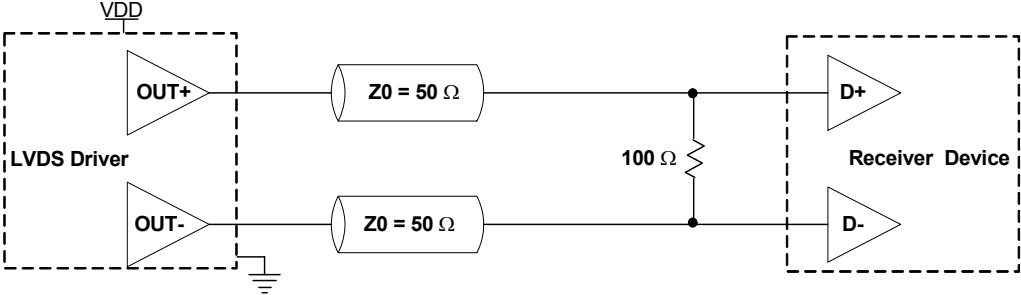
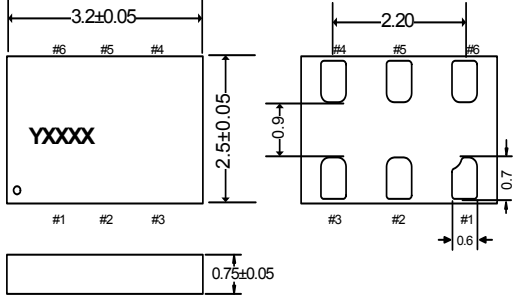
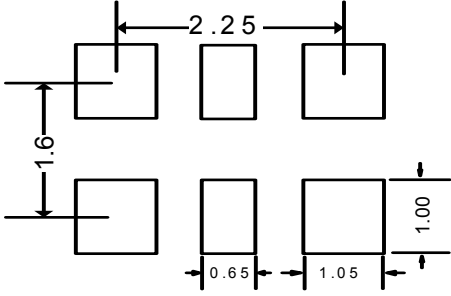
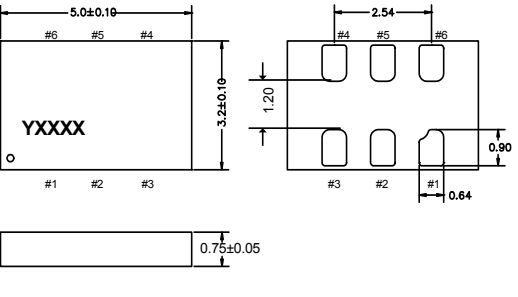
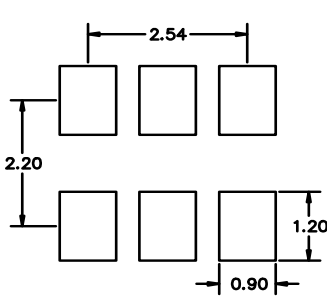
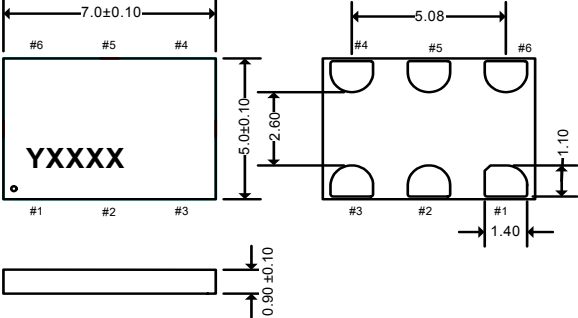
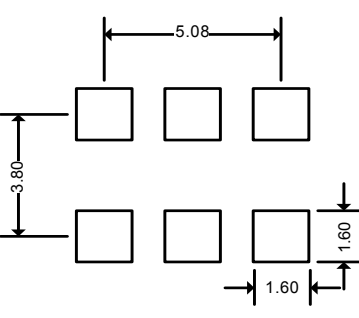

Figure 6. LVDS Single Termination (Load Terminated)

### Dimensions and Patterns

Package Size – Dimensions (Unit: mm) <sup>[1]</sup>	Recommended Land Pattern (Unit: mm) <sup>[2]</sup>
<p><b>3.2 x 2.5x 0.75 mm</b></p> 	
<p><b>5.0 x 3.2 x 0.75 mm</b></p> 	
<p><b>7.0 x 5.0x 0.90 mm</b></p> 	

**Notes:**

1. Top Marking: Y denotes manufacturing origin and XXXX denotes manufacturing lot number. The value of "Y" will depend on the assembly location of the device.
2. A capacitor of value 0.1  $\mu$ F between Vdd and GND is recommended.

### Ordering Information

SiT9120AC-1C2-33E 125.000000T

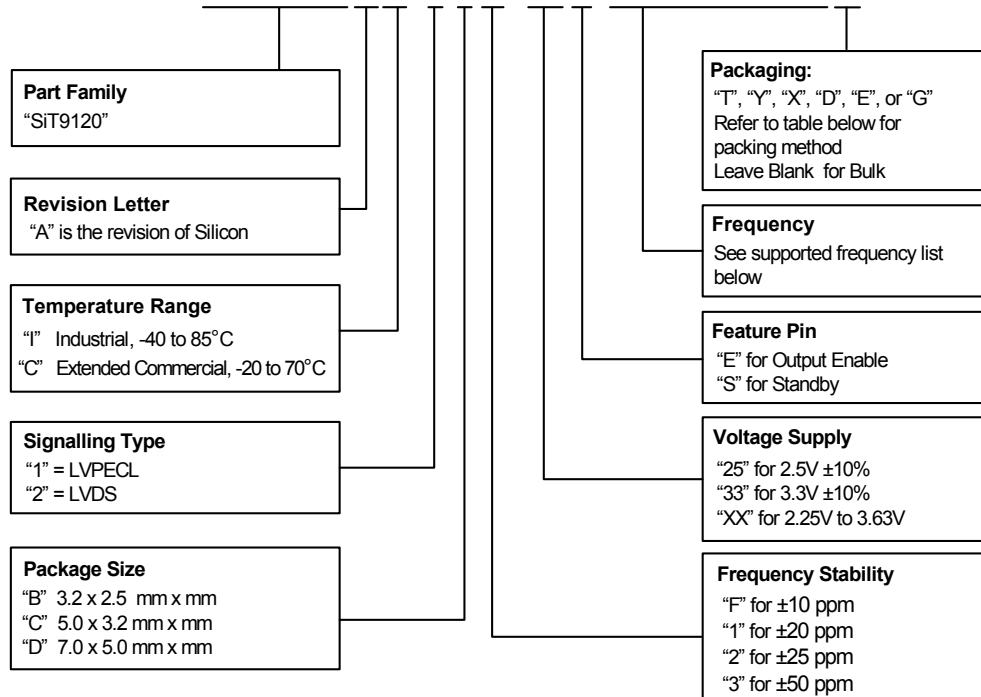

### Supported Frequencies

25.000000 MHz	50.000000 MHz	74.175824 MHz	74.250000 MHz	75.000000 MHz	98.304000 MHz	100.000000 MHz	106.250000 MHz
125.000000 MHz	133.000000 MHz	133.300000 MHz	133.330000 MHz	133.333000 MHz	133.333300 MHz	133.333330 MHz	133.333333 MHz
148.351648 MHz	148.500000 MHz	150.000000 MHz	155.520000 MHz	156.250000 MHz	161.132800 MHz	166.000000 MHz	166.600000 MHz
166.660000 MHz	166.666000 MHz	166.666600 MHz	166.666660 MHz	166.666666 MHz	200.000000 MHz	212.500000 MHz	

### Ordering Codes for Supported Tape & Reel Packing Method

Device Size	8 mm T&R (3ku)	8 mm T&R (1ku)	8 mm T&R (250u)	12 mm T&R (3ku)	12 mm T&R (1ku)	12 mm T&R (250u)	16 mm T&R (3ku)	16 mm T&R (1ku)	16 mm T&R (250u)
7.0 x 5.0 mm	-	-	-	-	-	-	T	Y	X
5.0 x 3.2 mm	-	-	-	T	Y	X	-	-	-
3.2 x 2.5 mm	D	E	G	T	Y	X	-	-	-

### Revision History

Version	Release Date	Change Summary
1.01	2/20/13	Original
1.02	11/23/13	Added input specifications, LVPECL/LVDS waveforms, packaging T&R options
1.03	2/6/14	Added 8mm T&R option
1.04	3/3/14	Added $\pm 10$ ppm
1.05	7/23/14	Include Thermal Consideration Table
1.06	10/3/14	Modified Thermal Consideration values

---

© SiTime Corporation 2014. The information contained herein is subject to change at any time without notice. SiTime assumes no responsibility or liability for any loss, damage or defect of a Product which is caused in whole or in part by (i) use of any circuitry other than circuitry embodied in a SiTime product, (ii) misuse or abuse including static discharge, neglect or accident, (iii) unauthorized modification or repairs which have been soldered or altered during assembly and are not capable of being tested by SiTime under its normal test conditions, or (iv) improper installation, storage, handling, warehousing or transportation, or (v) being subjected to unusual physical, thermal, or electrical stress.

**Disclaimer:** SiTime makes no warranty of any kind, express or implied, with regard to this material, and specifically disclaims any and all express or implied warranties, either in fact or by operation of law, statutory or otherwise, including the implied warranties of merchantability and fitness for use or a particular purpose, and any implied warranty arising from course of dealing or usage of trade, as well as any common-law duties relating to accuracy or lack of negligence, with respect to this material, any SiTime product and any product documentation. Products sold by SiTime are not suitable or intended to be used in a life support application or component, to operate nuclear facilities, or in other mission critical applications where human life may be involved or at stake. All sales are made conditioned upon compliance with the critical uses policy set forth below.

**CRITICAL USE EXCLUSION POLICY**  
BUYER AGREES NOT TO USE SITIME'S PRODUCTS FOR ANY APPLICATION OR IN ANY COMPONENTS USED IN LIFE SUPPORT DEVICES OR TO OPERATE NUCLEAR FACILITIES OR FOR USE IN OTHER MISSION-CRITICAL APPLICATIONS OR COMPONENTS WHERE HUMAN LIFE OR PROPERTY MAY BE AT STAKE.

SiTime owns all rights, title and interest to the intellectual property related to SiTime's products, including any software, firmware, copyright, patent, or trademark. The sale of SiTime products does not convey or imply any license under patent or other rights. SiTime retains the copyright and trademark rights in all documents, catalogs and plans supplied pursuant to or ancillary to the sale of products or services by SiTime. Unless otherwise agreed to in writing by SiTime, any reproduction, modification, translation, compilation, or representation of this material shall be strictly prohibited.



# Supplemental Information

The Supplemental Information section is not part of the datasheet and is for informational purposes only.

# Silicon MEMS Outperforms Quartz

## Best Reliability

Silicon is inherently more reliable than quartz. Unlike quartz suppliers, SiTime has in-house MEMS and analog CMOS expertise, which allows SiTime to develop the most reliable products. Figure 1 shows a comparison with quartz technology.

### Why is SiTime Best in Class:

- SiTime’s MEMS resonators are vacuum sealed using an advanced EpiSeal™ process, which eliminates foreign particles and improves long term aging and reliability
- World-class MEMS and CMOS design expertise

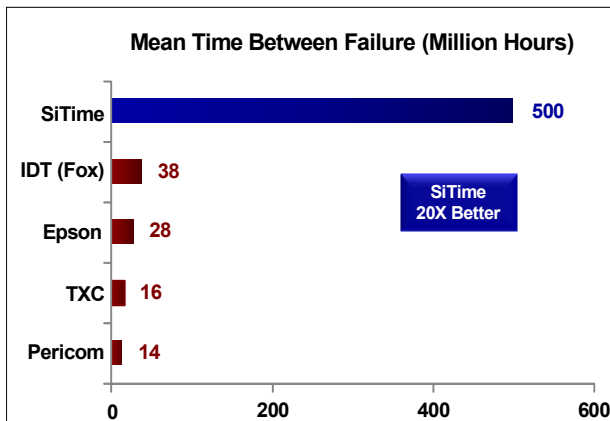

Figure 1. Reliability Comparison<sup>[1]</sup>

## Best Aging

Unlike quartz, MEMS oscillators have excellent long term aging performance which is why every new SiTime product specifies 10-year aging. A comparison is shown in Figure 2.

### Why is SiTime Best in Class:

- SiTime’s MEMS resonators are vacuum sealed using an advanced EpiSeal process, which eliminates foreign particles and improves long term aging and reliability
- Inherently better immunity of electrostatically driven MEMS resonator

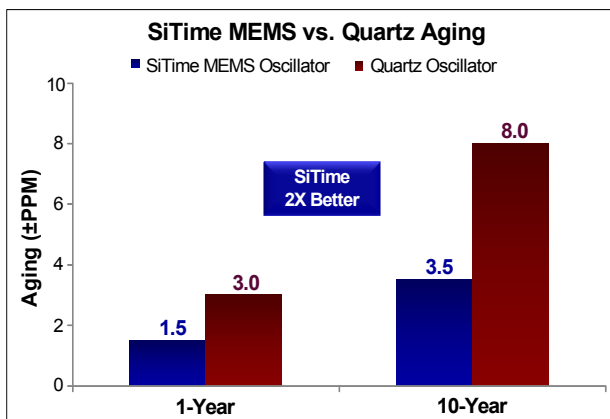

Figure 2. Aging Comparison<sup>[2]</sup>

## Best Electro Magnetic Susceptibility (EMS)

SiTime’s oscillators in plastic packages are up to 54 times more immune to external electromagnetic fields than quartz oscillators as shown in Figure 3.

### Why is SiTime Best in Class:

- Internal differential architecture for best common mode noise rejection
- Electrostatically driven MEMS resonator is more immune to EMS

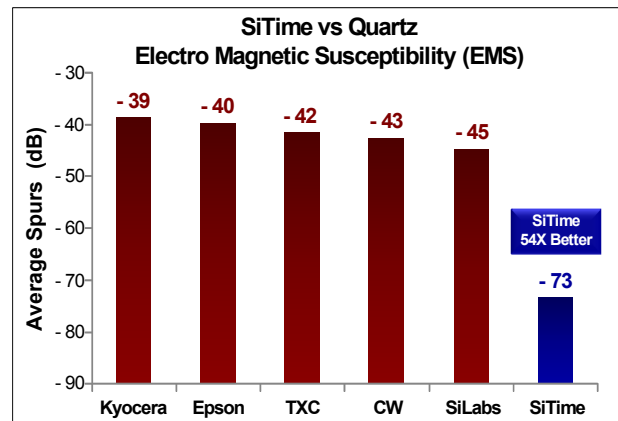

Figure 3. Electro Magnetic Susceptibility (EMS)<sup>[3]</sup>

## Best Power Supply Noise Rejection

SiTime’s MEMS oscillators are more resilient against noise on the power supply. A comparison is shown in Figure 4.

### Why is SiTime Best in Class:

- On-chip regulators and internal differential architecture for common mode noise rejection
- Best analog CMOS design expertise

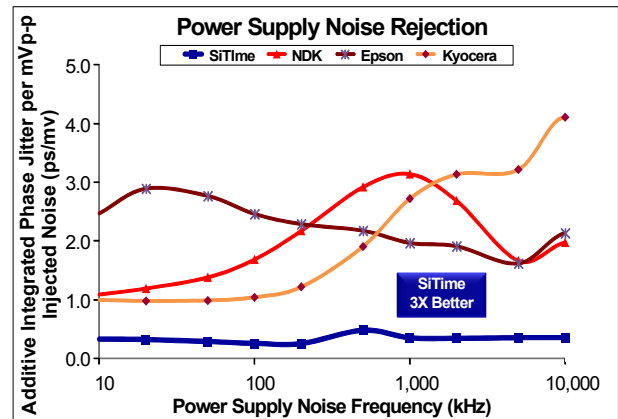

Figure 4. Power Supply Noise Rejection<sup>[4]</sup>

## Best Vibration Robustness

High-vibration environments are all around us. All electronics, from handheld devices to enterprise servers and storage systems are subject to vibration. Figure 5 shows a comparison of vibration robustness.

### Why is SiTime Best in Class:

- The moving mass of SiTime’s MEMS resonators is up to 3000 times smaller than quartz
- Center-anchored MEMS resonator is the most robust design

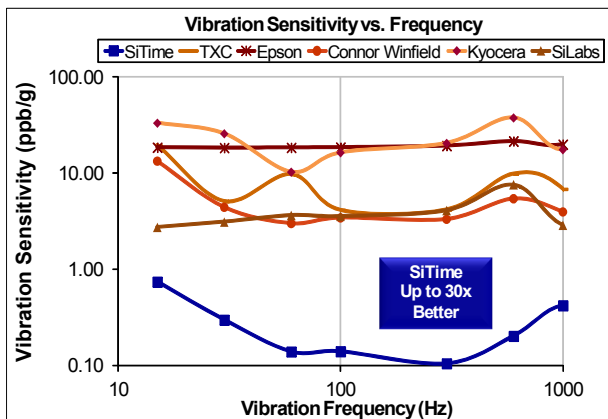

Figure 5. Vibration Robustness<sup>[5]</sup>

## Best Shock Robustness

SiTime’s oscillators can withstand at least 50,000 g shock. They all maintain their electrical performance in operation during shock events. A comparison with quartz devices is shown in Figure 6.

### Why is SiTime Best in Class:

- The moving mass of SiTime’s MEMS resonators is up to 3000 times smaller than quartz
- Center-anchored MEMS resonator is the most robust design

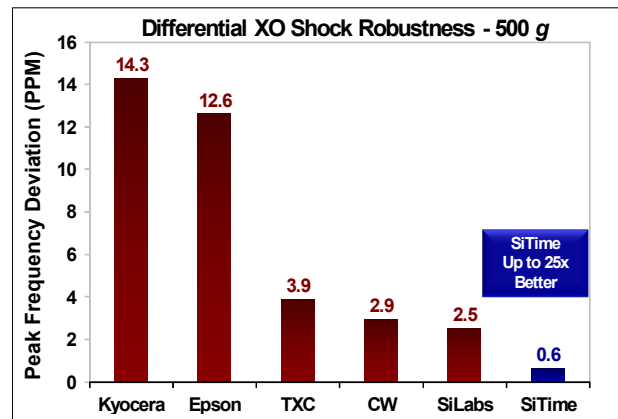

Figure 6. Shock Robustness<sup>[6]</sup>

### Notes:

1. Data Source: Reliability documents of named companies.
2. Data source: SiTime and quartz oscillator devices datasheets.
3. Test conditions for Electro Magnetic Susceptibility (EMS):
  - According to IEC EN61000-4.3 (Electromagnetic compatibility standard)
  - Field strength: 3V/m
  - Radiated signal modulation: AM 1 kHz at 80% depth
  - Carrier frequency scan: 80 MHz – 1 GHz in 1% steps
  - Antenna polarization: Vertical
  - DUT position: Center aligned to antenna

**Devices used in this test:**

  - SiTime, SiT9120AC-1D2-33E156.250000 - MEMS based - 156.25 MHz
  - Epson, EG-2102CA 156.2500M-PHPAL3 - SAW based - 156.25 MHz
  - TXC, BB-156.250MBE-T - 3rd Overtone quartz based - 156.25 MHz
  - Kyocera, KC7050T156.250P30E00 - SAW based - 156.25 MHz
  - Connor Winfield (CW), P123-156.25M - 3rd overtone quartz based - 156.25 MHz
  - SiLabs, Si590AB-BDG - 3rd overtone quartz based - 156.25 MHz
4. 50 mV pk-pk Sinusoidal voltage.
 

**Devices used in this test:**

  - SiTime, SiT8208AI-33-33E-25.000000, MEMS based - 25 MHz
  - NDK, NZ2523SB-25.6M - quartz based - 25.6 MHz
  - Kyocera, KC2016B25MOC1GE00 - quartz based - 25 MHz
  - Epson, SG-310SCF-25M0-MB3 - quartz based - 25 MHz
5. **Devices used in this test:** same as EMS test stated in Note 3.
6. Test conditions for shock test:
  - MIL-STD-883F Method 2002
  - Condition A: half sine wave shock pulse, 500-g, 1ms
  - Continuous frequency measurement in 100 μs gate time for 10 seconds

**Devices used in this test:** same as EMS test stated in Note 3
7. Additional data, including setup and detailed results, is available upon request to qualified customers. Please contact [productsupport@sitime.com](mailto:productsupport@sitime.com).

# Document Feedback Form



The Smart Timing Choice™

SiTime values your input in improving our documentation. Click [here](#) for our online feedback form or fill out and email the form below to [productsupport@sitime.com](mailto:productsupport@sitime.com).

1. Does the Electrical Characteristics table provide complete information? Yes No

If No, what parameters are missing?

---

2. Is the organization of this document easy to follow? Yes No

If "No," please suggest improvements that we can make:

---

3. Is there any application specific information that you would like to see in this document? (Check all that apply)

EMI                      Termination recommendations                      Shock and vibration performance                      Other

If "Other," please specify:

---

4. Are there any errors in this document? Yes No

If "Yes", please specify (what and where):

---

5. Do you have additional recommendations for this document?

---

Name \_\_\_\_\_

Title \_\_\_\_\_

Company \_\_\_\_\_

Address \_\_\_\_\_

City / State or Province / Postal Code / Country \_\_\_\_\_

Telephone \_\_\_\_\_

Application \_\_\_\_\_

Would you like a reply? Yes No

Thank you for your feedback. Please click the email icon in your Adobe Reader tool bar and send to [productsupport@sitime.com](mailto:productsupport@sitime.com). Or you may use our [online feedback form](#).